

# GAMA PROFISSIONAL

## CATÁLOGO FITA LED



### SÉRIES

<b>FLEXISTRIP</b>	IP20
<b>FLEXIPROOF</b>	IP65
<b>CONFORSTRIP</b>	WW>W
<b>COLORSTRIP</b>	RGB
<b>COLORSTRIP+W</b>	RGB+W

# ANATOMIA DA FITA

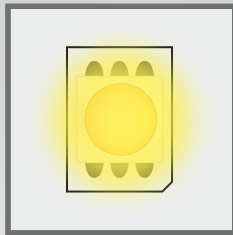

## CHIP

As gamas profissionais Flexistrip, Flexiproof, Conforstrip, Colorstrip estão equipadas com leds de elevado rendimento e excelente restituição de cor, apresentando CRI>80 e CRI>94.

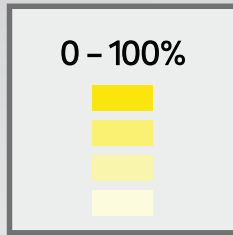

## DIMAVEL

Os LEDs são totalmente dimáveis e compatíveis com 80% dos sistemas para regulação de fluxo existentes no mercado. Esta versatilidade permite criar ambientes relaxantes e de maior actividade variando a sua intensidade.

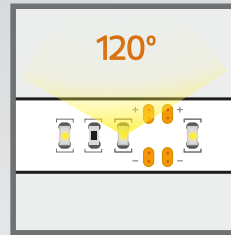

## ABERTURA

Leds com ângulo de 120o oferecem grande aproveitamento da luz emitida. Efectuam uma iluminação bastante dispersiva sendo adequada aos mais variados espaços, sejam eles comerciais, domésticos ou industriais.

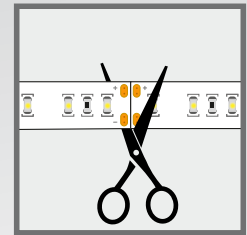

## CORTÁVEL

Permite efectuar pequenos cortes podendo o seu comprimento ser ajustado livremente sem se preocupar com as dimensões disponíveis no espaço onde vai ser instalada.

## CRI

(Color Rendering Index) A restituição de cor está relacionada com a forma como os objectos surgem sob o efeito de uma luz branca, quanto maior for o CRI, melhor será a sua restituição de cor.

Numa escala em que o seu valor máximo é igual a 100 (luz solar), a gama Flexistrip e Flexiproof apresentam valores muito aproximados CRI>80 e CRI>94. Desenvolvidas especificamente para fins profissionais, graças ao seu elevado índice de restituição, consegue-se proporcionar aos objectos iluminados uma aparência natural e com vivacidade, por isso atractiva.

### CRI 70



### CRI 80



### CRI 90



## ICONOGRAFIA



Temperatura de Funcionamento



Raio de Curvatura Mínimo



A/mt



Espessura Pista de Cobre (OZ)



Espaçamento entre LEDs



Dimensão mínima de Corte e Número existente de LEDs



Tipo de Fita Adesiva



Período de Garantia (Fitas IP20)



Tipo de LED



Índice de Restituição de Cor (CRI)



Índice de Restituição de Cor (CRI)



Permite Regulação da Intensidade Luminosa



Permite Selecção da Tonalidade do Branco



Permite Selecção de Cor



Permite Selecção de Cor + Branco



Conecção sem fios por Rádio frequência (RF)



Botão Selector de intensidade ou cor

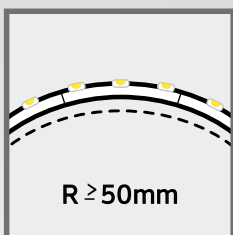

#### FLEXIBILIDADE

Totalmente flexíveis, podem ser dobradas verticalmente, permitindo por isso ser colocada até mesmo nos locais onde se pensava ser impossível.

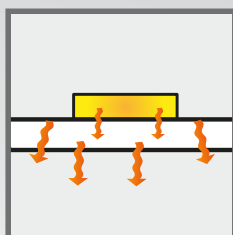

#### PERFORMANCE

As temperaturas de funcionamento elevadas levam a uma vida útil curta do LED. As nossas fitas apresentam um PCB com maior espessura (OZ) e percentagem de cobre de forma a efectuar uma melhor dissipação de calor, aumentando assim a vida útil do led.

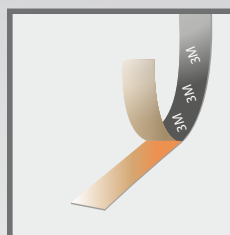

#### APLICAÇÃO

Equipadas com fita 3M tipo 9448, assegura uma rápida e fácil colocação no perfil, garantindo uma boa aderência ao longo do tempo.

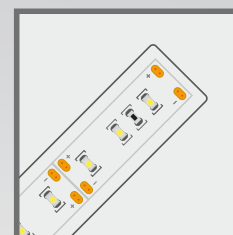

#### PROTECÇÃO

A protecção adicional sobre os leds em silicone, conferem um índice de protecção IP65, possibilitando a instalação em locais onde existam elevados níveis de poeiras e algum índice de humidade.

## ÍNDICE GERAL

Referência	Página
Flexistrip 23W	04/05
Flexistrip 14,4W	06/07
Flexistrip 9,6W	08/09
Flexistrip 4,8W	10/11
Conforstrip WW+W	12/13
Flexiproof 14,4W	14/15
Flexiproof 9,6W	16/17
Colorstrip	18/19
Colorstrip IP65	20/21
Colorstrip+W	22/23

Referência	Página
Conectores	24/25
Perfis Alumínio	26/27
Controlador Bluetooth	28/29
Controlador RF	30/31
Esquemas Ligação RF	32
Fontes Alimentação	33
Índice Referências	34/35
Tabela de Preços	38/39



### Perfis Alumínio

#### AluPRO/90°

1431001001P

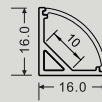

**Clip-90**  
1430450001  
Clip Fixação



**Tp90-F**  
1432050001  
Topo Final



**Tp90-E**  
1432050002  
Topo Entrada

#### AluPRO/S

1431001002P

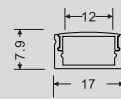

**Clip-S**  
1430450002  
Clip Fixação



**Tp/S-F**  
1432050005  
Topo Final



**Tp/S-E**  
1432050004  
Topo Entrada

#### AluPRO/E

1431001003P

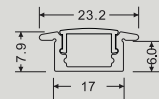

**Tp/E-F**  
1432050003  
Topo Final



**Tp/E-E**  
1432050006  
Topo Entrada

Comprimento do perfil: 2020 mm  
Perfil inclui difusor em Policarbonato Opalino

Para mais detalhes consultar páginas 26/27

Dimensões | Dimensions | Dimensiones | Dimensiones

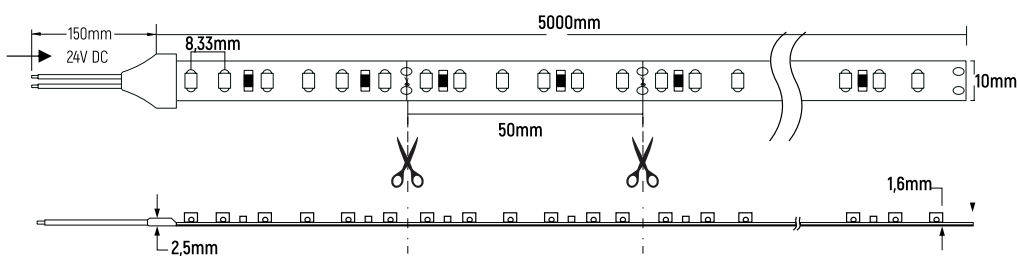

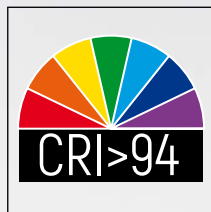
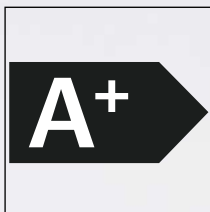

# FLEXISTRIP

23W WW 1625Lm/mt  
23W NW 1735Lm/mt

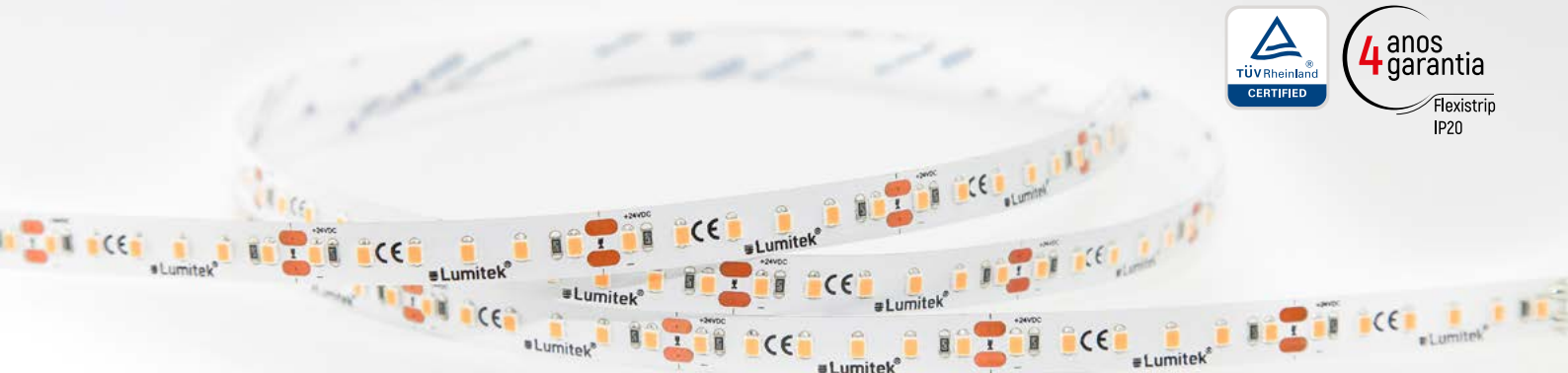

WW : Branco Quente | Warm White  
NW : Branco Neutro | Neutral White



## Especificações | Specifications | Spécifications | Especificaciones

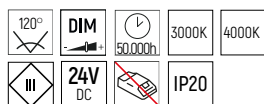

-20°C...+40°C

R ≥ 50mm

A/mt 1,2A

OZ = 3

8,33mm

50...50mm (6 LED's)

3M 9448A Fita Adesiva Dupla Face

## Standards

EN 55015 : 2013  
EN 61547 : 2009  
2014/30/UE  
2011/65/UE

**CE RoHS**

1431000010  
1431000011

**FLEXISTRIP** [23W 3000K WW 120LED = 1625Lm/mt]  
**FLEXISTRIP** [23W 4000K NW 120LED = 1735Lm/mt]



## Acessórios | Accessories | Accessoires | Accesorios

### Controladores | Controllers | Contrôleur | Controladores



1430560001

Controlador Dimmer (Comando Remoto + Receptor)

### Conectores | Connectors | Connecteurs | Conectores (120Led/Mt)



1430490007

União linear  
2 Contactos (10mm)



1431240007

Conector c/cabo ligação  
2 Contactos (10mm)

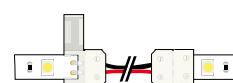

1430810007

Extensão 15cm  
2 Contactos (10mm)

### Fontes de Alimentação | Power Supply | Source de courant | Fuente de alimentación



24V DC (LRS)  
35/75/100/150W



24V DC (RSP)  
200/320W



24V DC (DR)  
30/60/100W



24V DC (NDR)  
240W



### Perfis Alumínio

#### AluPRO/90°

1431001001P

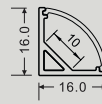

**Clip-90**  
1430450001  
Clip Fixação



**Tp90-F**  
1432050001  
Topo Final



**Tp90-E**  
1432050002  
Topo Entrada

#### AluPRO/S

1431001002P

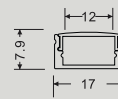

**Clip-S**  
1430450002  
Clip Fixação



**Tp/S-F**  
1432050005  
Topo Final



**Tp/S-E**  
1432050004  
Topo Entrada

#### AluPRO/E

1431001003P

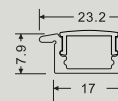

**Tp/E-F**  
1432050003  
Topo Final



**Tp/E-E**  
1432050006  
Topo Entrada

Comprimento do perfil: 2020 mm  
Perfil inclui difusor em Policarbonato Opalino

Para mais detalhes consultar páginas 26/27

Dimensões | Dimensions | Dimensións | Dimensiones

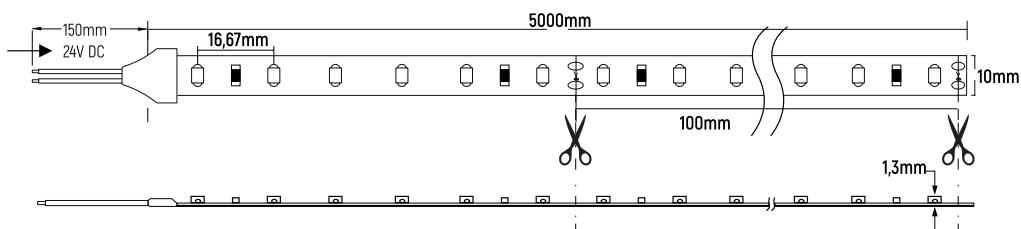

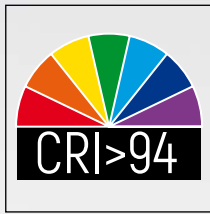
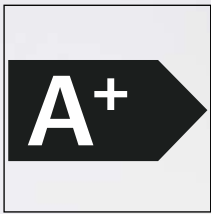

# FLEXISTRIP

14,4W WW 990Lm/mt

14,4W NW 1050Lm/mt



WW : Branco Quente | Warm White  
NW : Branco Neutro | Neutral White



## Especificações | Specifications | Spécifications | Especificaciones



-20°C...+40°C

R≥50mm

A/mt 0,58A

OZ = 3

16,67mm

100...100mm [6 LED's]

3M 9448A Fita Adesiva Dupla Face

## Standards

EN 55015 : 2013  
EN 61547 : 2009  
2014/30/UE  
2011/65/UE

**CE RoHS**

1431000006  
1431000007

**FLEXISTRIP** (14,4W 3000K 60LED = 990L/mt)  
**FLEXISTRIP** (14,4W 4000K 60LED = 1050L/mt)



## Acessórios | Accessories | Accessoires | Accesorios

### Controladores | Controllers | Contrôleur | Controladores



1430560001  
Controlador Dimmer (Comando Remoto + Receptor)

### Conectores | Connectors | Connecteurs | Conectores (60Led/Mt)



1430490002  
União linear  
2 Contactos (10mm)



1431240002  
Conector c/cabo ligação  
2 Contactos (10mm)



1430810004  
Extensão 15cm  
2 Contactos (10mm)

### Fontes de Alimentação | Power Supply | Source de courant | Fuente de alimentación



24V DC (LRS)  
35/75/100/150W



24V DC (RSP)  
200/320W



24V DC (DR)  
30/60/100W



24V DC (NDR)  
240W



**Perfis Alumínio**

**AluPRO/90°**  
1431001001P

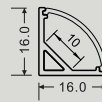

**Clip-90**  
1430450001  
Clip Fixação

**Tp90-F**  
1432050001  
Topo Final

**Tp90-E**  
1432050002  
Topo Entrada

**AluPRO/S**  
1431001002P

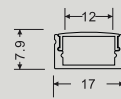

**Clip-S**  
1430450002  
Clip Fixação

**Tp/S-F**  
1432050005  
Topo Final

**Tp/S-E**  
1432050004  
Topo Entrada

**AluPRO/E**  
1431001003P

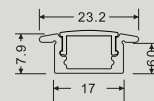

**Tp/E-F**  
1432050003  
Topo Final

**Tp/E-E**  
1432050006  
Topo Entrada

Comprimento do perfil: 2020 mm  
Perfil inclui difusor em Policarbonato Opalino

Para mais detalhes consultar páginas 26/27

Dimensões | Dimensions | Dimensións | Dimensiones

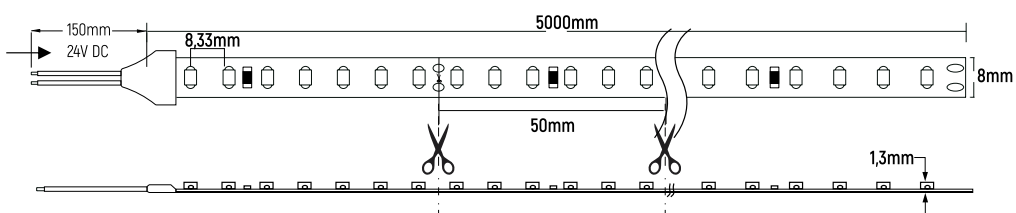



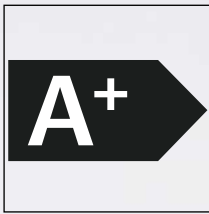

# FLEXISTRIP

9,6W WW 740Lm/mt  
9,6W CW 768Lm/mt

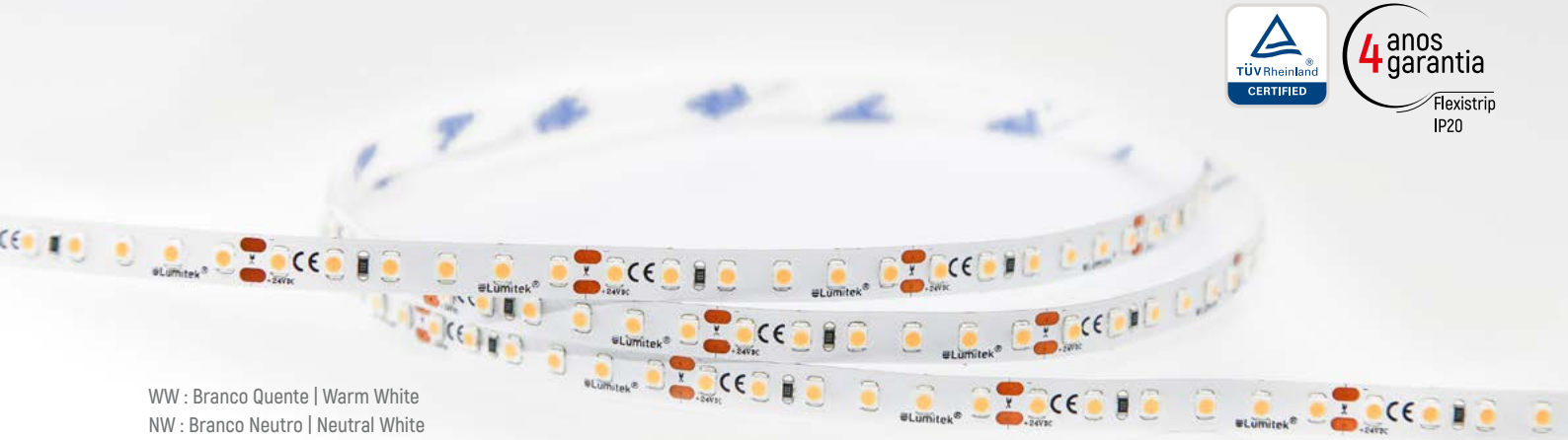

WW : Branco Quente | Warm White  
NW : Branco Neutro | Neutral White



### Especificações | Specifications | Spécifications | Especificaciones

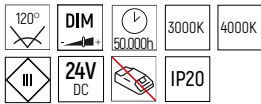

-20°C...+40°C

R≥50mm

A/mt 0,36A

OZ = 3

8,33mm

50...50mm (6 LED's)

**9448A** Fita Adesiva Dupla Face

### Standards

EN 55015 : 2013  
EN 61547 : 2009  
2014/30/UE  
2011/65/UE



**1431000008 FLEXISTRIP** [9,6W 3000K 120LED = 740Lm/mt]  
**1431000009 FLEXISTRIP** [9,6W 4000K 120LED = 768Lm/mt]



### Accessórios | Accessories | Accessoires | Accesorios

#### Controladores | Controllers | Contrôleur | Controladores



**1430560001**  
Controlador Dimmer (Comando Remoto + Receptor)

#### Conectores | Connectors | Connecteurs | Conectores (120Led/Mt)



**1430490006**  
União linear  
2 Contactos (8mm)



**1431240006**  
Conector c/cabo ligação  
2 Contactos (8mm)



**1430810006**  
Extensão 15cm  
2 Contactos (8mm)

#### Fontes de Alimentação | Power Supply | Source de courant | Fuente de alimentación



24V DC (LRS)  
35/75/100/150W



24V DC (RSP)  
200/320W



24V DC (DR)  
30/60/100W



24V DC (NDR)  
240W



### Perfis Alumínio

#### AluPRO/90°

1431001001P

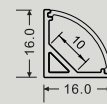

**Clip-90**  
1430450001  
Clip Fixação



**Tp90-F**  
1432050001  
Topo Final



**Tp90-E**  
1432050002  
Topo Entrada

#### AluPRO/S

1431001002P

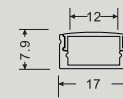

**Clip-S**  
1430450002  
Clip Fixação



**Tp/S-F**  
1432050005  
Topo Final



**Tp/S-E**  
1432050004  
Topo Entrada

#### AluPRO/E

1431001003P

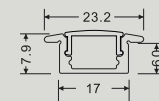

**Tp/E-F**  
1432050003  
Topo Final



**Tp/E-E**  
1432050006  
Topo Entrada

Comprimento do perfil: 2020 mm  
Perfil inclui difusor em Policarbonato Opalino

Para mais detalhes consultar páginas 26/27

Dimensões | Dimensions | Dimensiones | Dimensiones

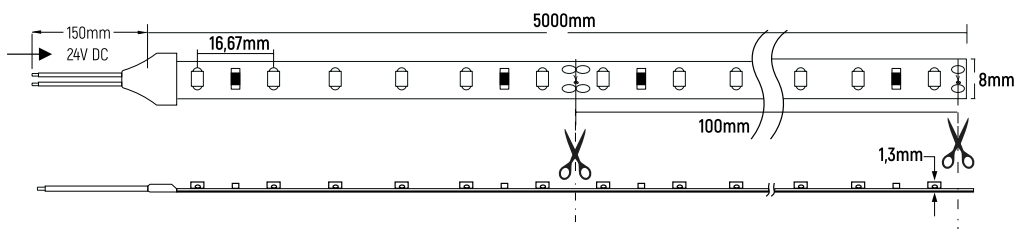

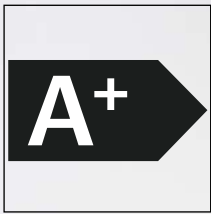

# FLEXISTRIP

4,8W WW 360Lm/mt  
4,8W CW 390Lm/mt



WW : Branco Quente | Warm White  
NW : Branco Neutro | Neutral White



## Especificações | Specifications | Spécifications | Especificaciones



-20°C...+40°C

R≥50mm

A/mt 0,2A

OZ = 2

16,67mm

100...100mm [6 LED's]

**3M 9448A** Fita Adesiva Dupla Face

## Standards

EN 55015 : 2013  
EN 61547 : 2009  
2014/30/UE  
2011/65/UE



1431000004  
1431000005

**FLEXISTRIP** (4,8W 3000K 60LED = 360Lm/mt)  
**FLEXISTRIP** (4,8W 4000K 60LED = 390Lm/mt)



## Acessórios | Accessories | Accessoires | Accesorios

### Controladores | Controllers | Contrôleur | Controladores



1430560001

Controlador Dimmer (Comando Remoto + Receptor)

### Conectores | Connectors | Connecteurs | Conectores (60Led/Mt)



1430490001

União linear  
2 Contactos (8mm)



1431240001

Conector c/cabo ligação  
2 Contactos (8mm)



1430810003

Extensão 15cm  
2 Contactos (8mm)

### Fontes de Alimentação | Power Supply | Source de courant | Fuente de alimentación



24V DC (LRS)  
35/75/100/150W



24V DC (RSP)  
200/320W



24V DC (DR)  
30/60/100W



24V DC (NDR)  
240W



### Perfis Alumínio

#### AluPRO/90°

1431001001P

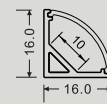

**Clip-90**  
1430450001  
Clip Fixação



**Tp90-F**  
1432050001  
Topo Final



**Tp90-E**  
1432050002  
Topo Entrada

#### AluPRO/S

1431001002P

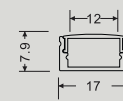

**Clip-S**  
1430450002  
Clip Fixação



**Tp/S-F**  
1432050005  
Topo Final



**Tp/S-E**  
1432050004  
Topo Entrada

#### AluPRO/E

1431001003P

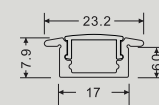

**Tp/E-F**  
1432050003  
Topo Final



**Tp/E-E**  
1432050006  
Topo Entrada

Comprimento do perfil: 2020 mm  
Perfil inclui difusor em Policarbonato Opalino

Para mais detalhes consultar páginas 26/27

Dimensões | Dimensions | Dimensjóns | Dimensiones

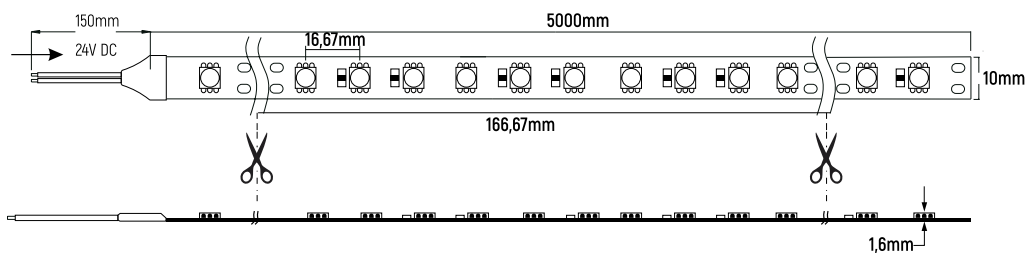

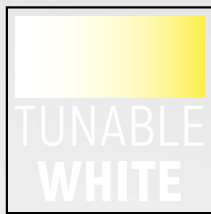
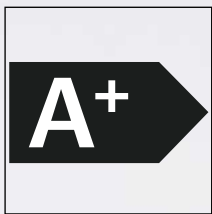

# CONFORSTRIP

## 14,4W 1200Lm/mt

2700K 4000K 5000K 6500K



4 anos garantia

Conforstrip  
WW+W  
IP20



Especificações | Specifications | Spécifications | Especificaciones



-20°C...+40°C

R≥50mm

A/mt 0,58A

OZ = 3

16,67mm

166,67...166,67mm (10 LED's)

3M 9448A Fita Adesiva Dupla Face

Standards

EN 55015 : 2013

EN 61547 : 2009

2014/30/UE

2011/65/UE

CE RoHS

143100012

**CONFORSTRIP** [14,4W 2700K - 6500K 60LED = 1200Lm/mt]



Accessórios | Accessories | Accessoires | Accesorios

Controladores | Controllers | Contrôleur | Controladores



1430560004

Controlador Variação Cor (WW+W) [Comando Remoto + Receptor]

Conectores | Connectors | Connecteurs | Conectores (60Led/Mt)



1430490005

União linear  
3 Contactos (10mm)



1431240005

Conector c/cabo ligação  
3 Contactos (10mm)



1430810005

Extensão 15cm  
3 Contactos (10mm)

Fontes de Alimentação | Power Supply | Source de courant | Fuente de alimentación



24V DC (LRS)  
35/75/100/150W



24V DC (RSP)  
200/320W



24V DC (DR)  
30/60/100W



24V DC (NDR)  
240W

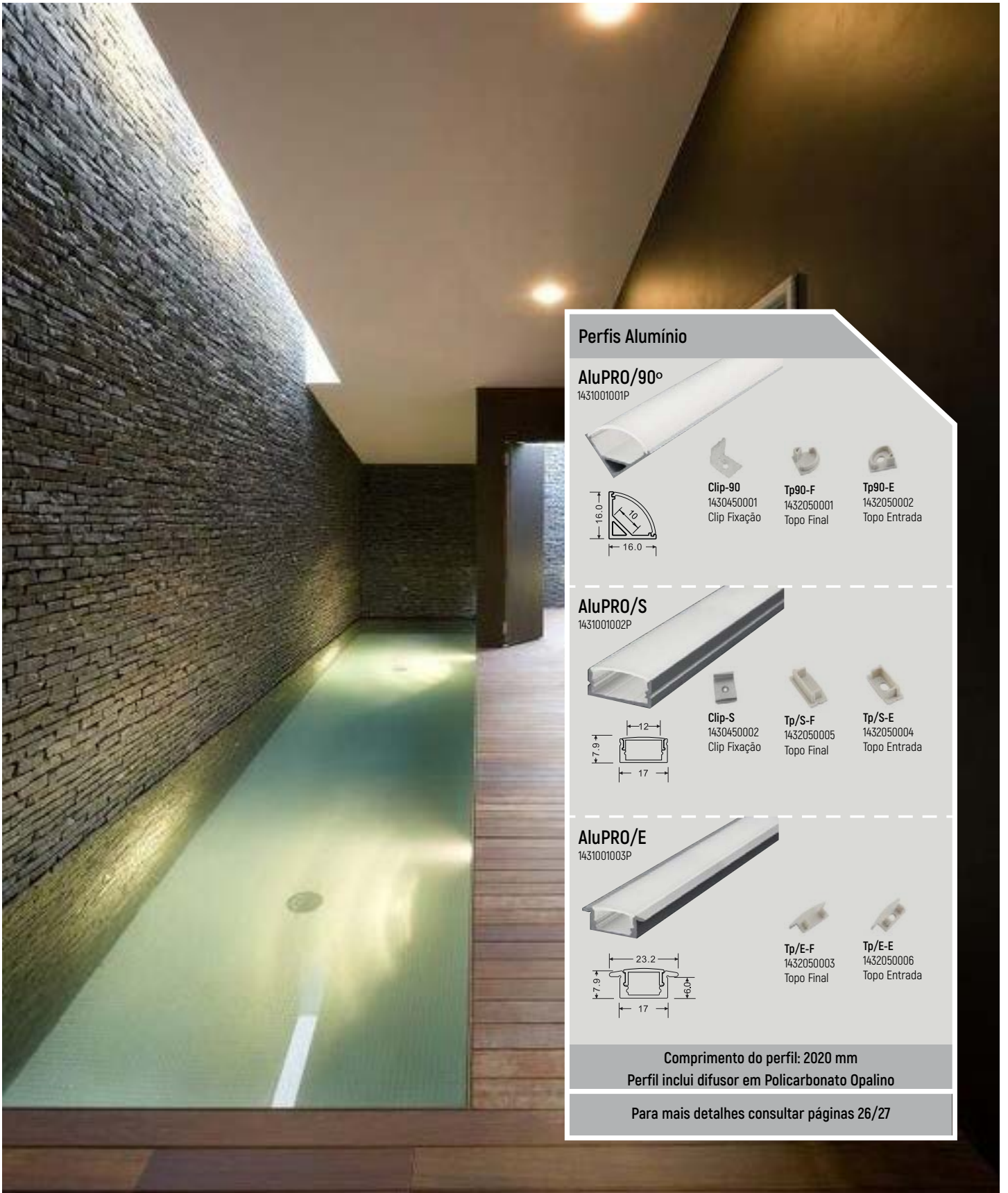

### Perfis Alumínio

#### AluPRO/90° 1431001001P

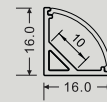

**Clip-90**  
1430450001  
Clip Fixação

**Tp90-F**  
1432050001  
Topo Final

**Tp90-E**  
1432050002  
Topo Entrada

#### AluPRO/S 1431001002P

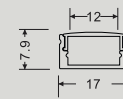

**Clip-S**  
1430450002  
Clip Fixação

**Tp/S-F**  
1432050005  
Topo Final

**Tp/S-E**  
1432050004  
Topo Entrada

#### AluPRO/E 1431001003P

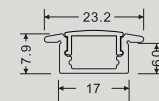

**Tp/E-F**  
1432050003  
Topo Final

**Tp/E-E**  
1432050006  
Topo Entrada

Comprimento do perfil: 2020 mm  
Perfil inclui difusor em Policarbonato Opalino

Para mais detalhes consultar páginas 26/27

Dimensões | Dimensions | Dimensións | Dimensiones

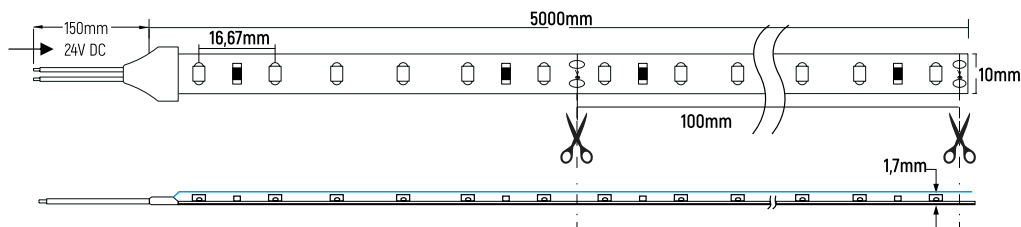

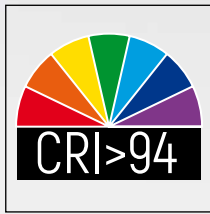
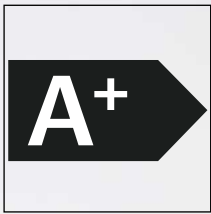

# FLEXIPROOF

14,4W WW 990Lm/mt  
14,4W CW 1050Lm/mt



WW : Branco Quente | Warm White  
NW : Branco Neutro | Neutral White



Especificações | Specifications | Spécifications | Especificaciones

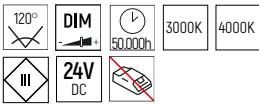

-20°C...+40°C

R≥50mm

A/mt 0,58A

OZ = 3

16,67mm

100...100mm [6 LED's]

Fita Adesiva Dupla Face

Revestimento em Silicone

Standards

EN 55015 : 2013  
EN 61547 : 2009  
2014/30/UE  
2011/65/UE



1431000013  
1431000014

**FLEXIPROOF** [14,4W 3000K 60LED = 990Lm/mt]  
**FLEXIPROOF** [14,4W 4000K 60LED = 1050Lm/mt]



Acessórios | Accessories | Accessoires | Accesorios

Controladores | Controllers | Contrôleurs | Controladores



1430560001  
Controlador Dimmer (Comando Remoto + Receptor)

Conectores | Connectors | Connecteurs | Conectores (60Led/Mt)

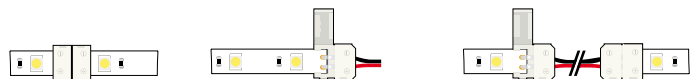

1430490002  
União linear  
2 Contactos (10mm)

1431240002  
Conector c/cabo ligação  
2 Contactos (10mm)

1430810004  
Extensão 15cm  
2 Contactos (10mm)

Fontes de Alimentação | Power Supply | Source de courant | Fuente de alimentación



24V DC (LPV)  
60/100/150W



24V DC (ELG)  
200W



24V DC (HLG)  
320W



### Perfis Alumínio

#### AluPRO/90°

1431001001P

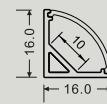

**Clip-90**  
1430450001  
Clip Fixação



**Tp90-F**  
1432050001  
Topo Final



**Tp90-E**  
1432050002  
Topo Entrada

#### AluPRO/S

1431001002P

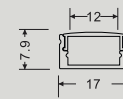

**Clip-S**  
1430450002  
Clip Fixação



**Tp/S-F**  
1432050005  
Topo Final



**Tp/S-E**  
1432050004  
Topo Entrada

#### AluPRO/E

1431001003P

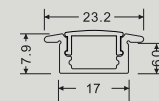

**Tp/E-F**  
1432050003  
Topo Final



**Tp/E-E**  
1432050006  
Topo Entrada

Comprimento do perfil: 2020 mm  
Perfil inclui difusor em Policarbonato Opalino

Para mais detalhes consultar páginas 26/27

Dimensões | Dimensions | Dimensións | Dimensiones

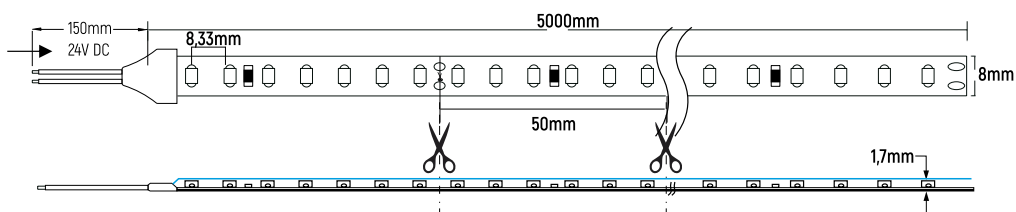



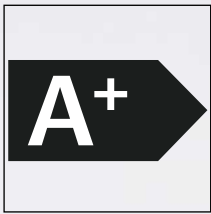

# FLEXIPROOF

9,6W WW 740Lm/mt  
9,6W CW 768Lm/mt



WW : Branco Quente | Warm White  
NW : Branco Neutro | Neutral White



Especificações | Specifications | Spécifications | Especificaciones

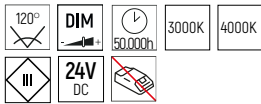

-20°C...+40°C

R≥50mm

A/mt 0,36A

OZ = 3

8,33mm

50...50mm (6 LED's)

Fita Adesiva Dupla Face

Revestimento em Silicone

Standards

EN 55015 : 2013  
EN 61547 : 2009  
2014/30/UE  
2011/65/UE

**CE RoHS**

1431000015  
1431000016

**FLEXIPROOF** (9,6W 3000K 120LED = 740Lm/mt)  
**FLEXIPROOF** (9,6W 4000K 120LED = 768Lm/mt)



Accessórios | Accessories | Accessoires | Accesorios

Controladores | Controllers | Contrôleur | Controladores



1430560001  
Controlador Dimmer (Comando Remoto + Receptor)

Conectores | Connectors | Connecteurs | Conectores (120Led/Mt)



1430490006  
União linear  
2 Contactos (8mm)



1431240006  
Conector c/cabo ligação  
2 Contactos (8mm)



1430810006  
Extensão 15cm  
2 Contactos (8mm)

Fontes de Alimentação | Power Supply | Source de courant | Fuente de alimentación



24V DC (LPV)  
60/100/150W



24V DC (ELG)  
200W



24V DC (HLG)  
320W



### Perfis Alumínio

#### AluPRO/90°

1431001001P

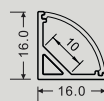

**Clip-90**  
1430450001  
Clip Fixação



**Tp90-F**  
1432050001  
Topo Final



**Tp90-E**  
1432050002  
Topo Entrada

#### AluPRO/S

1431001002P

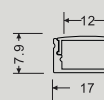

**Clip-S**  
1430450002  
Clip Fixação



**Tp/S-F**  
1432050005  
Topo Final



**Tp/S-E**  
1432050004  
Topo Entrada

#### AluPRO/E

1431001003P

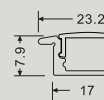

**Tp/E-F**  
1432050003  
Topo Final



**Tp/E-E**  
1432050006  
Topo Entrada

Comprimento do perfil: 2020 mm  
Perfil inclui difusor em Policarbonato Opalino

Para mais detalhes consultar páginas 26/27

Dimensões | Dimensions | Dimensións | Dimensiones

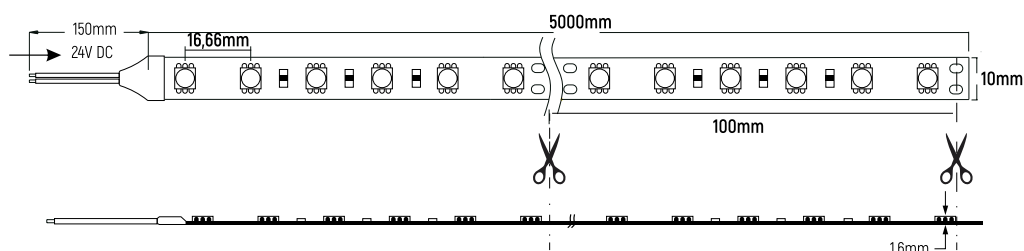

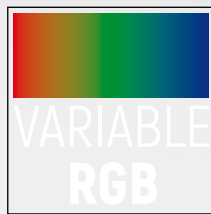
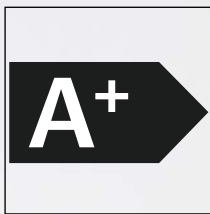

# COLORSTRIP

14,4W 420Lm/mt

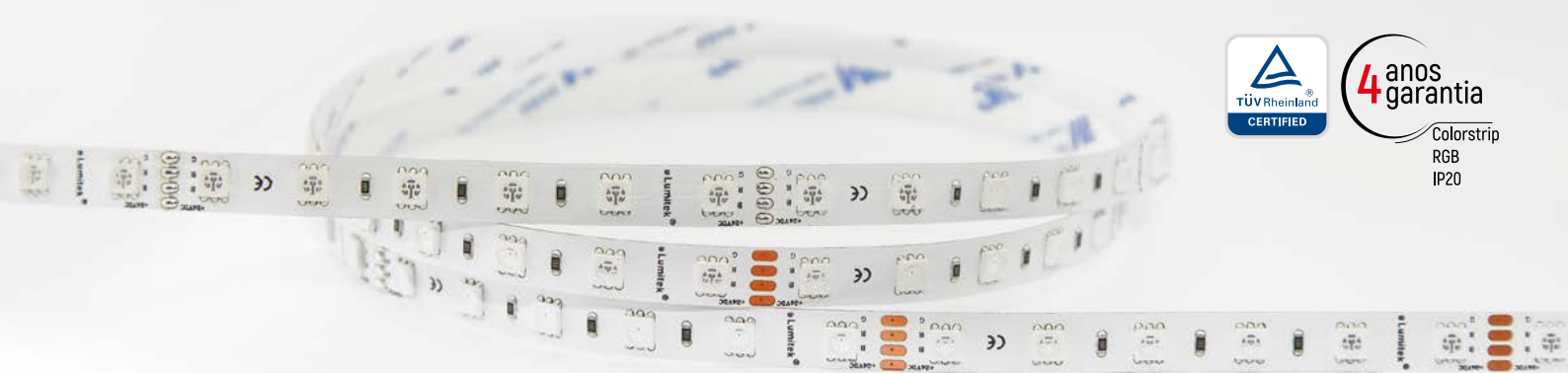

### Especificações | Specifications | Spécifications | Especificaciones



-20°C...+40°C

R≥50mm

A/mt 0,58A

OZ = 3

16,66mm

100...100mm [6 LED's]

**3M 9448A** Fita Adesiva Dupla Face

### Standards

EN 55015 : 2013  
EN 61547 : 2009  
2014/30/UE  
2011/65/UE



### 143100001 COLORSTRIP [14,4W RGB 60LED = 420Lm/mt]



### Accessórios | Accessories | Accessoires | Accesorios

#### Controladores | Controllers | Contrôleur | Controladores



1430560002  
Controlador RGB (Comando Remoto + Receptor)

#### Conectores | Connectors | Connecteurs | Conectores (60Led/Mt)

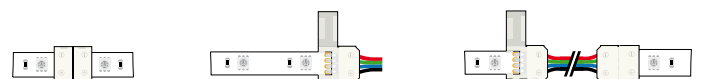

1430490003  
União RGB linear  
4 Contactos (10mm)

1431240003  
Conector RGB c/cabo ligação  
4 Contactos (10mm)

1430810001  
Extensão 15cm RGB  
4 Contactos (10mm)

#### Fontes de Alimentação | Power Supply | Source de courant | Fuente de alimentación



24V DC (LRS)  
35/75/100/150W



24V DC (RSP)  
200/320W



24V DC (DR)  
30/60/100W



24V DC (NDR)  
240W



### Perfis Alumínio

#### AluPRO/90°

1431001001P

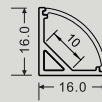

**Clip-90**  
1430450001  
Clip Fixação

**Tp90-F**  
1432050001  
Topo Final

**Tp90-E**  
1432050002  
Topo Entrada

#### AluPRO/S

1431001002P

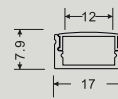

**Clip-S**  
1430450002  
Clip Fixação

**Tp/S-F**  
1432050005  
Topo Final

**Tp/S-E**  
1432050004  
Topo Entrada

#### AluPRO/E

1431001003P

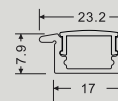

**Tp/E-F**  
1432050003  
Topo Final

**Tp/E-E**  
1432050006  
Topo Entrada

Comprimento do perfil: 2020 mm  
Perfil inclui difusor em Policarbonato Opalino

Para mais detalhes consultar páginas 26/27

Dimensões | Dimensions | Dimensións | Dimensiones

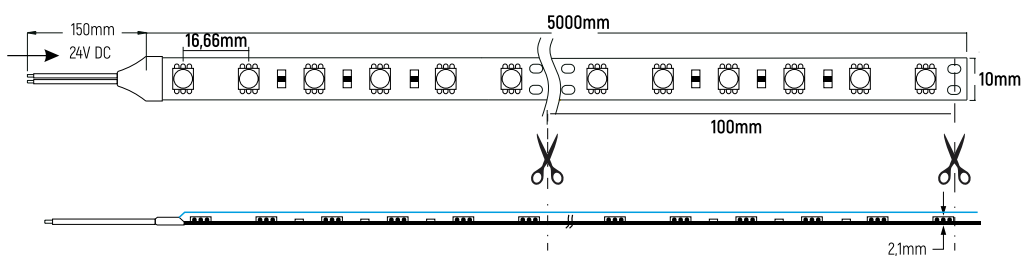

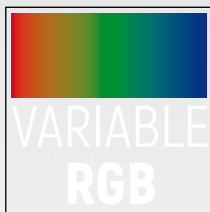
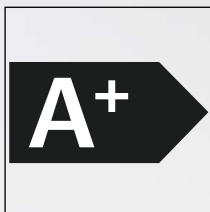

# COLORSTRIP

14,4W 420Lm/mt



Especificações | Specifications | Spécifications | Especificaciones

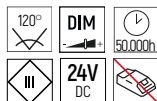

-20°C...+40°C

R≥50mm

A/mt 0,58A

OZ = 3

16,66mm

100...100mm (6 LED's)

Fita Adesiva Dupla Face

Revestimento em Silicone

Standards

EN 55015 : 2013  
EN 61547 : 2009  
2014/30/UE  
2011/65/UE



1431000002... **COLORSTRIP** (14,4W RGB 60LED = 420Lm/mt)



Accessórios | Accessories | Accessoires | Accesorios

Controladores | Controllers | Contrôleurs | Controladores



1430560002  
Controlador RGB (Comando Remoto + Receptor)

Conectores | Connectors | Connecteurs | Conectores (60Leds/Mt)

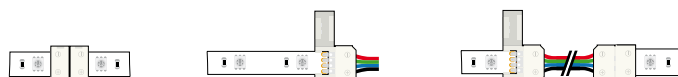

1430490003  
União RGB linear  
4 Contactos (10mm)

1431240003  
Conector RGB c/cabo ligação  
4 Contactos (10mm)

1430810001  
Extensão 15cm RGB  
4 Contactos (10mm)

Fontes de Alimentação | Power Supply | Source de courant | Fuente de alimentación



24V DC (LPV)  
60/100/150W



24V DC (ELG)  
200W



24V DC (HLG)  
320W



### Perfis Alumínio

#### AluPRO/90°

1431001001P

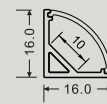

**Clip-90**  
1430450001  
Clip Fixação



**Tp90-F**  
1432050001  
Topo Final



**Tp90-E**  
1432050002  
Topo Entrada

#### AluPRO/S

1431001002P

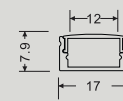

**Clip-S**  
1430450002  
Clip Fixação



**Tp/S-F**  
1432050005  
Topo Final



**Tp/S-E**  
1432050004  
Topo Entrada

#### AluPRO/E

1431001003P

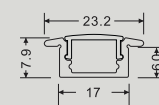

**Tp/E-F**  
1432050003  
Topo Final



**Tp/E-E**  
1432050006  
Topo Entrada

Comprimento do perfil: 2020 mm  
Perfil inclui difusor em Policarbonato Opalino

Para mais detalhes consultar páginas 26/27

Dimensões | Dimensions | Dimensións | Dimensiones

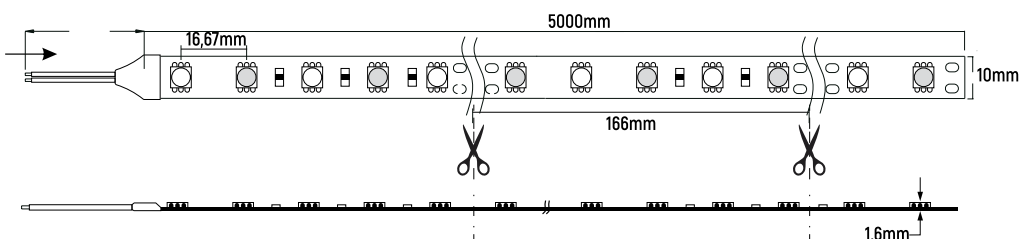

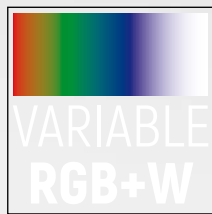
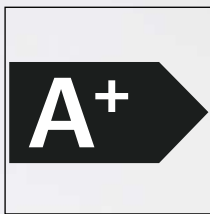

# COLORSTRIP+W

## 14,4W 610Lm/mt

### RGB + 6000K

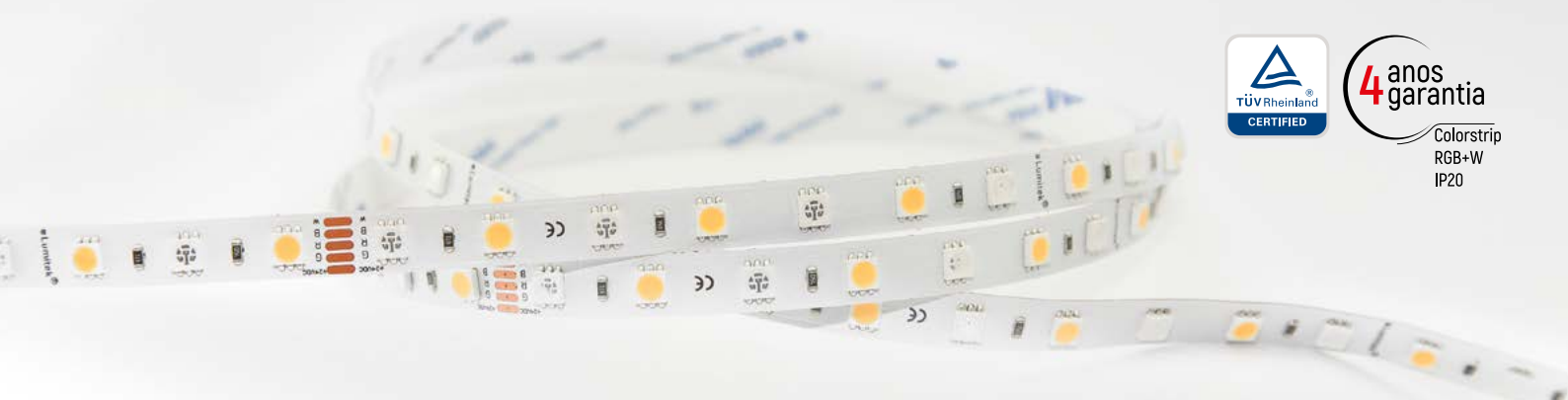

# SOSO LED

Especificações | Specifications | Spécifications | Especificaciones

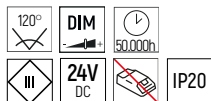

-20°C...+40°C

R≥50mm

A/mt 0,58A

OZ = 3

16,67mm

166...166mm (10 LED's)

Fita Adesiva Dupla Face

Standards

EN 55015 : 2013

EN 61547 : 2009

2014/30/UE

2011/65/UE

**CE RoHS**

1431000003

**COLORSTRIP+W** (14,4W RGB+6000K 60LED = 610Lm/mt)



Accessórios | Accessories | Accessoires | Accesorios

Controladores | Controllers | Contrôleurs | Controladores



1430560003

Controlador RGB+W (Comando Remoto + Receptor)

Conectores | Connectors | Connecteurs | Conectores (60Led/Mt)



1430490004

União RGB+W linear  
5 Contactos (10mm)



1431240004

Conector RGB+W c/cabo ligação  
5 Contactos (10mm)



1430810002

Extensão 15cm RGB+W  
5 Contactos (10mm)

Fontes de Alimentação | Power Supply | Source de courant | Fuente de alimentación



24V DC (LRS)  
35/75/100/150W



24V DC (RSP)  
200/320W



24V DC (DR)  
30/60/100W



24V DC (NDR)  
240W

# CONECTORES

CONNECTORS | CONNECTEURS | CONECTORES



Compatível com FLEXISTRIP e FLEXIPROOF  
(8MM)



Cod. | Ref. | Descrição

1431240001 | **Conector 8mm** | Ligação com cabo para Flexistrip / Flexiproof (8mm 2 cont. **60Led/mt**)

1431240006 | **Conector 8mm** | Ligação com cabo para Flexistrip / Flexiproof (8mm 2 cont. **120Led/mt**)

Connect cable 15cms for Flexistrip and Flexiproof [8mm - 2 contacts]

Connecteur avec cable 15cms pour Flexistrip et Flexiproof [8mm - 2 contacts]

Cable de conexión 15cms para Flexistrip y Flexiproof [8mm - 2 contactos]

1430490001 | **União Linear 8mm** | União linear para Flexistrip / Flexiproof (8mm 2 cont. **60Led/mt**)

1430490006 | **União Linear 8mm** | União linear para Flexistrip / Flexiproof (8mm 2 cont. **120Led/mt**)

Linear connector for Flexistrip and Flexiproof [8mm - 2 contacts]

Connecteur Linéaire pour Flexistrip et Flexiproof [8mm - 2 contacts]

Conector lineal para Flexistrip y Flexiproof [8mm - 2 contactos]

1430810003 | **Extensão 8mm** | Extensão 15cms para Flexistrip / Flexiproof (8mm 2 cont. **60Led/mt**)

1430810006 | **Extensão 8mm** | Extensão 15cms para Flexistrip / Flexiproof (8mm 2 cont. **120Led/mt**)

Extension with 15cms for Flexistrip and Flexiproof [8mm - 2 contacts]

Extension avec 15cms pour Flexistrip et Flexiproof [8mm - 2 contacts]

Extensión 15cms para Flexistrip y Flexiproof [8mm - 2 contactos]



Compatível com FLEXISTRIP e FLEXIPROOF  
(10MM)



Cod. | Ref. | Descrição

1431240002 | **Conector 10mm** | Ligação com cabo para Flexistrip / Flexiproof (10mm 2 cont. **60Led/mt**)

1431240007 | **Conector 10mm** | Ligação com cabo para Flexistrip / Flexiproof (10mm 2 cont. **120Led/mt**)

Connect cable 15cms for Flexistrip and Flexiproof [10mm - 2 contacts]

Connecteur avec cable 15cms pour Flexistrip et Flexiproof [10mm - 2 contacts]

Cable de conexión 15cms para Flexistrip y Flexiproof [10mm - 2 contactos]

1430490002 | **União Linear 10mm** | União linear para Flexistrip / Flexiproof (10mm 2 cont. **60Led/mt**)

1430490007 | **União Linear 10mm** | União linear para Flexistrip / Flexiproof (10mm 2 cont. **120Led/mt**)

Linear connector for Flexistrip and Flexiproof [10mm - 2 contacts]

Connecteur Linéaire pour Flexistrip et Flexiproof [10mm - 2 contacts]

Conector lineal para Flexistrip y Flexiproof [10mm - 2 contactos]

1430810004 | **Extensão 10mm** | Extensão 15cms para Flexistrip / Flexiproof (10mm 2 cont. **60Led/mt**)

1430810007 | **Extensão 10mm** | Extensão 15cms para Flexistrip / Flexiproof (10mm 2 cont. **120Led/mt**)

Extension with 15cms for Flexistrip and Flexiproof [10mm - 2 contacts]

Extension avec 15cms pour Flexistrip et Flexiproof [10mm - 2 contacts]

Extensión 15cms para Flexistrip y Flexiproof [10mm - 2 contactos]



Compatível com CONFORSTRIP  
(10MM)



Cod. | Ref. | Descrição

1431240005 | **Conector WW+W** | Cabo ligação 15cms para fita Conforstrip WW+W (10mm - 3 contactos)

Connect cable 15cms for Conforstrip WW+W [10mm - 3 contacts]

Connecteur avec cable 15cms pour Conforstrip WW+W [10mm - 3 contacts]

Cable de conexión 15cms para Conforstrip WW+W [10mm - 3 contactos]

1430490005 | **União Linear WW+W** | Conector linear para fita Conforstrip WW+W (10mm - 3 contactos)

Linear connector for Conforstrip WW+W [10mm - 3 contacts]

Connecteur Linéaire pour Conforstrip WW+W [10mm - 3 contacts]

Conector lineal para Conforstrip WW+W [10mm - 3 contactos]

1430810005 | **Extensão WW+W** | Extensão 15cms para fita Conforstrip WW+W (10mm - 3 contactos)

Extension with 15cms for Conforstrip WW+W [10mm - 3 contacts]

Extension avec 15cms pour Conforstrip WW+W [10mm - 3 contacts]

Extensión 15cms para Conforstrip WW+W [10mm - 3 contactos]



# CONECTORES

CONNECTORS | CONNECTEURS | CONECTORES



Compatível com COLORSTRIP RGB  
(10MM)

Cod. | Ref. | Descrição



1431240003 | **Conector RGB** | Cabo ligação 15cms para fita Colorstrip RGB [10mm - 4 contactos]  
Connect cable 15cms for Colorstrip RGB [10mm - 4 contacts]  
Connecteur avec cable 15cms pour Colorstrip RGB [10mm - 4 contacts]  
Cable de conexión 15cms para Colorstrip RGB [10mm - 4 contactos]



1430490003 | **União Linear RGB** | Conector linear para fita Colorstrip RGB [10mm - 4 contactos]  
Linear connector for Colorstrip RGB [10mm - 4 contacts]  
Connecteur Linéaire pour Colorstrip RGB [10mm - 4 contacts]  
Conector lineal para Colorstrip RGB [10mm - 4 contactos]



1430810001 | **Extensão RGB** | Extensão 15cms para fita Colorstrip RGB [10mm - 4 contactos]  
Extension with 15cms for Colorstrip RGB [10mm - 4 contacts]  
Extension avec 15cms pour Colorstrip RGB [10mm - 4 contacts]  
Extensión 15cms para Colorstrip RGB [10mm - 4 contactos]



Compatível com COLORSTRIP RGB+W  
(10MM)

Cod. | Ref. | Descrição



1431240004 | **Conector RGB+W** | Cabo ligação 15cms para fita Colorstrip RGB+W [10mm - 5 contactos]  
Connect cable 15cms for Colorstrip RGB+W [10mm - 5 contacts]  
Connecteur avec cable 15cms pour Colorstrip RGB+W [10mm - 5 contacts]  
Cable de conexión 15cms para Colorstrip RGB+W [10mm - 5 contactos]



1430490004 | **União Linear RGB+W** | Conector linear para fita Colorstrip RGB+W [10mm - 5 contactos]  
Linear connector for Colorstrip RGB+W [10mm - 5 contacts]  
Connecteur Linéaire pour Colorstrip RGB+W [10mm - 5 contacts]  
Conector lineal para Colorstrip RGB+W [10mm - 5 contactos]



1430810002 | **Extensão RGB+W** | Extensão 15cms para fita Colorstrip RGB+W [10mm - 5 contactos]  
Extension with 15cms for Colorstrip RGB+W [10mm - 5 contacts]  
Extension avec 15cms pour Colorstrip RGB+W [10mm - 5 contacts]  
Extensión 15cms para Colorstrip RGB+W [10mm - 5 contactos]

1431001001P

**ALUPRO 90°** Perfil alumínio saliente 90° 2020x16x16mm  
(difusor policarbonato opalino)

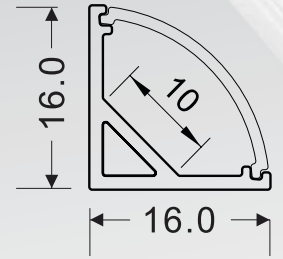

1430450001

**CLIP 90°** Clip de fixação para perfil alumínio AluPRO 90°



1432050001

**TP90° - F** Topo final para perfil alumínio AluPRO 90°



1432050002

**TP90° - E** Topo c/entrada para perfil alumínio AluPRO 90°



1431001002P

**ALUPRO/S** Perfil alumínio saliente 2020 x 17,1 x 7,9mm  
(difusor policarbonato opalino)

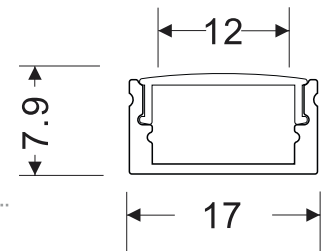

1430450001

**CLIP - S** Clip de fixação para perfil alumínio AluPRO/S



1432050005

**TP/S - F** Topo final para perfil alumínio saliente AluPRO/S



1432050004

**TP/S - E** Topo c/entrada para perfil alumínio saliente AluPRO/S



1431001003P

**ALUPRO/E** Perfil alumínio encastrar com aba 2020 x 23,2m  
(difusor policarbonato opalino)

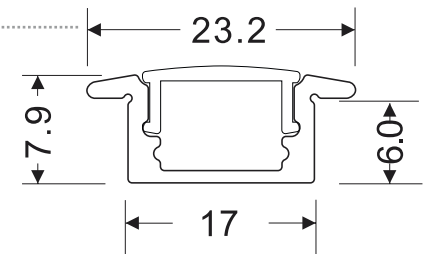

1432050003

**TP/E - F** Topo final para perfil alumínio encastrar com aba AluPRO/E



1432050006

**TP/E - E** Topo c/entrada para perfil alumínio encastrar com aba AluPRO/E



# PERFIS ALUMÍNIO

ALUMINIUM PROFILE | PROFIL D'ALUMINIUM | PERFIL DE ALUMINIO



## IMPORTANTE

Para o bom funcionamento e condições de garantia das fitas LED, **FLEXISTRIP**, **FLEXIPROOF**, **CONFORSTRIP**, **COLORSTRIP**, é recomendável a instalação em Perfis de Alumínio **AluPRO**.



# CONTROLADOR

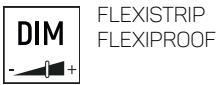
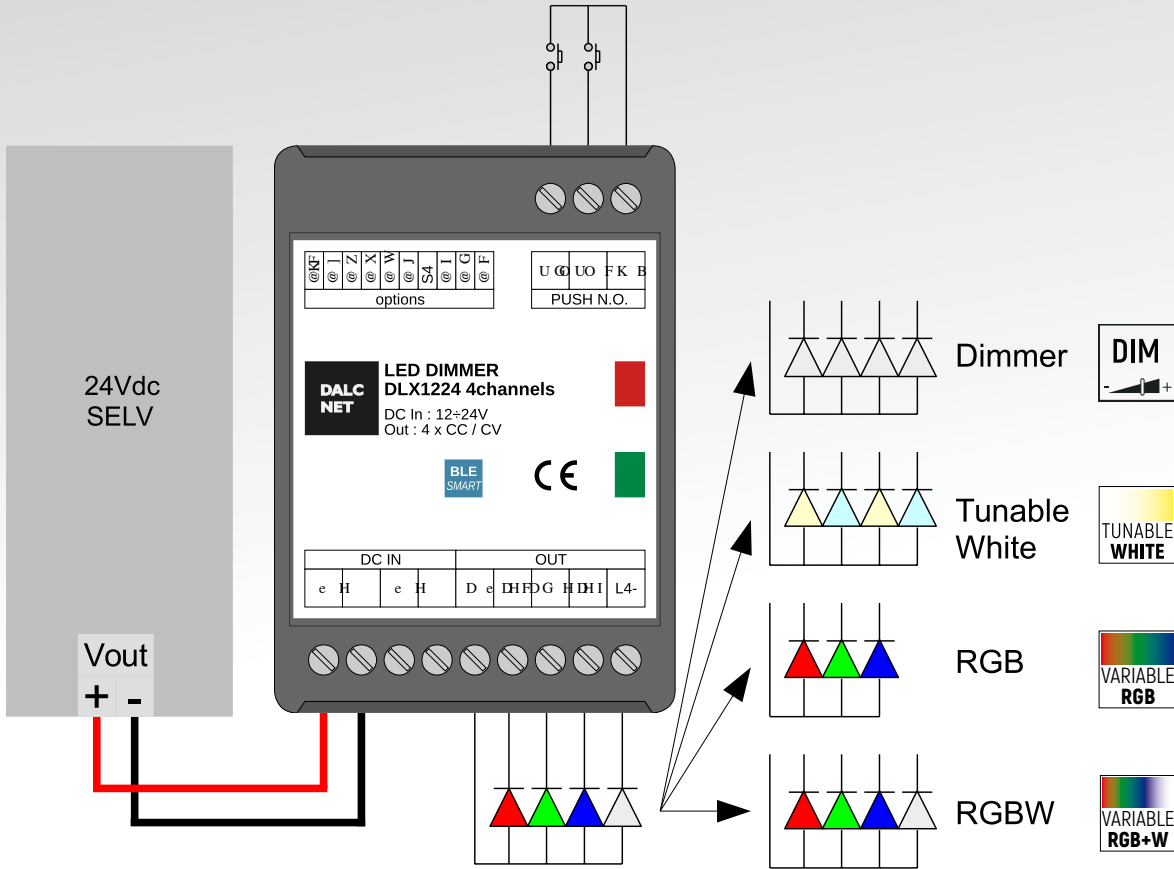

# CONTROLADOR



[BlueDimmer.com](http://BlueDimmer.com)

Download for  
**Android**

Download on the  
**App Store**

**BLE**  
SMART



**CE RoHS**

Dimensões | Dimensions | Dimensiones | Dimensiones

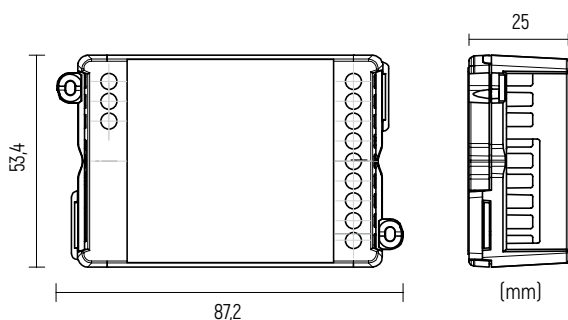

1000120134

**DLX1224-4CV-BLE** Smart Control Mobile

Sistema para controlo de iluminação via Bluetooth

Alimentação: 12-24Vdc

Saída: 4 Canais 4x2,5A máx. 10A Total

Temp. Funcionamento: min.-10 máx.+40°C

Índice Protecção: IP20

Peso: 125grs

Funcionalidades:

Regulação Fluxo (DIM)

Seleção Tonalidade (WW+W)

Seleção Cor (RGB)

Seleção Cor + Seleção de Branco (RGB+W)

Acender e Desligar Suave

# CONTROLADORES

Controllers | Contrôleur | Controladores

 **RF WIRELESS**



1430560001  
Controlador DIM



Sistema para controlo  
intensidade com comando  
para fita LED Flexistrip e  
Flexiproof



1430560004  
Controlador WW+W



Sistema para controlo  
Tonalidade da Cor com  
comando para fita LED  
Conforstrip WW+W



1430560002  
Controlador RGB  
Sistema para controlo de  
Cor  
com comando para fita LED  
Colorstrip RGB



**CE RoHS**

Dimensões | Dimensions | Dimensiones | Dimensiones

Receptor Mini



Receptor RF

Alimentação: 24Vdc

Saída: 3A x 3 Canais Máx 9A = 216W

Temp. Funcionamento: min.-30 máx.+55°C

Índice Protecção: IP20

Alcance: <50m

Func.: Regulação Fluxo [DIM] | Selecção Tonalidade [WW+W]

Selecção Cor [RGB] | Acender e Desligar Suave

Peso: 47grs

# CONTROLADORES

Controllers | Contrôleur | Controladores

 **RF WIRELESS**

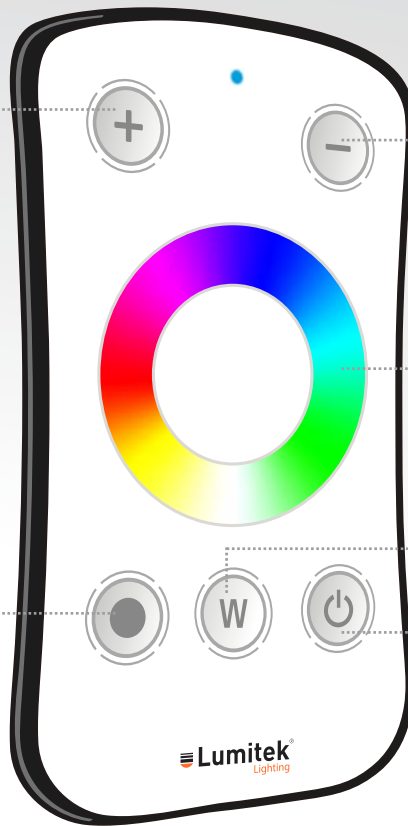

Botão  
Aumentar Intensidade (RGB)

Botão  
Diminuir Intensidade (RGB)

Círculo  
Selector de Cor

Botão  
Selector de Programas (11)  
(Efeito Estático, Flash, Suave)

Botão (W)  
ON/OFF

Botão (RGB+W)  
ON/OFF

- Programas
- Estático Vermelho
  - Estático Verde
  - Estático Azul
  - Estático Amarelo
  - Estático Violeta
  - Estático Ciano
  - Estático Branco
  - Flash RGB
  - Flash 7 Cores
  - Suave RGB
  - Suave 7 Cores

1430560003  
Controlador RGB+W  
Sistema para control de  
Cor + Branco com comando  
para fita LED Colorstrip  
RGB+W



**CE RoHS**

Dimensões | Dimensions | Dimensiones | Dimensiones

Receptor M

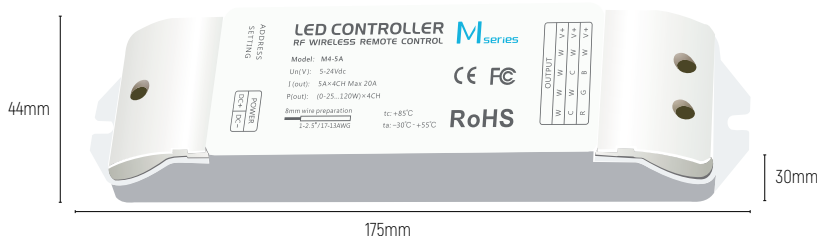

Receptor RF  
Alimentação: 24Vdc  
Saída: 5A x 4 Canais Máx 20A = 480W  
Temp. Funcionamento: min.-30 máx.+55°C  
Índice Protecção: IP20  
Alcance: <50m  
Func.: Selecção Cor e Intensidade (RGB+W) | Acender e Desligar Suave  
Peso: 125grs

Control

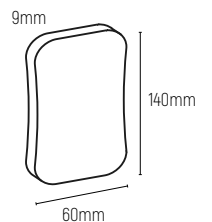

# SISTEMAS DE CONTROLO

ESQUEMAS DE LIGAÇÃO



SISTEMA DE CONTROLO INTENSIDADE  
1430560001

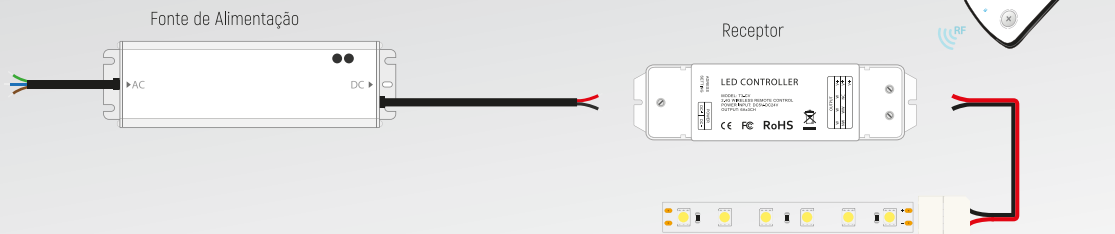

SISTEMA DE CONTROLO WW+W  
1430560004

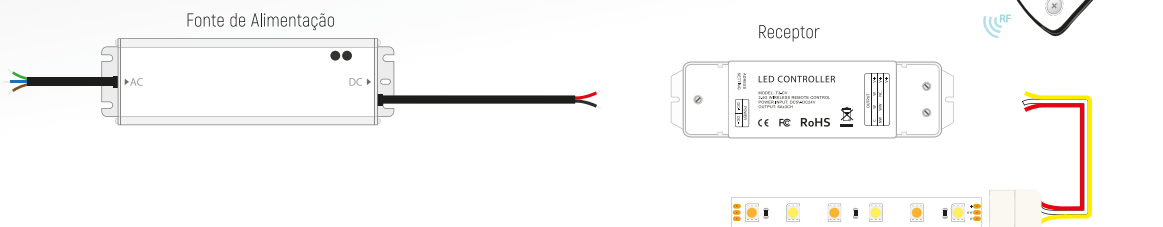

SISTEMA DE CONTROLO RGB  
1430560002

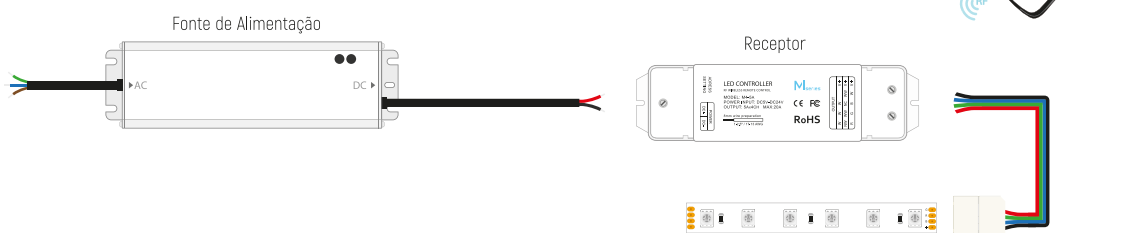

SISTEMA DE CONTROLO RGB+W  
1430560003

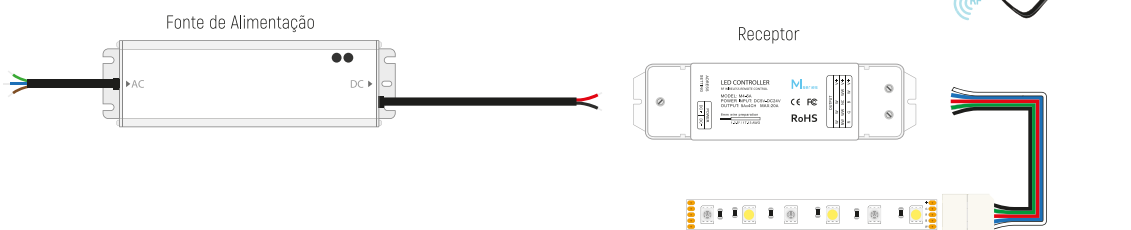



# FONTES ALIMENTAÇÃO

POWER SUPPLIES | SOURCE DE COURANT | FUENTE DE ALIMENTACIÓN

## STANDARD



LRS-35-24



LRS-75-24



LRS-100-24



LRS-150-24



RSP-200-24



RSP-320-24

Código	Referência	Alimentação	Saída	Potência	Corrente	PFC	DIM	IP	Class	CxLxA	Peso
1000120133	LRS-35-24	85-264VAC + 120-373VDC	24V DC	35W	1.5A		NO	20	I	99*82*30 (mm)	0,23Kg
1000120025	LRS-75-24	85-264VAC + 120-373VDC	24V DC	76,8W	3.2A		NO	20	I	99*97*30 (mm)	0,30Kg
1001002029	LRS-100-24	85-264VAC + 120-373VDC	24V DC	108W	4.5A		NO	20	I	129*97*30 (mm)	0,34Kg
1001001109	LRS-150-24	85-132VAC + 240-370VDC	24V DC	156W	6.5A		NO	20	I	159*97*30 (mm)	0,48Kg
1000120121	RSP-200-24	88-264VAC + 124-370VDC	24V DC	200W	8.4A	PF>0.95	NO	20	I	215*115*30 (mm)	0,72Kg
1000120122	RSP-320-24	88-264VAC + 124-370VDC	24V DC	321.6W	13.4A	PF>0.95	NO	20	I	215*115*30 (mm)	0,90Kg

## CALHA DIN



DR-30-24



DR-60-24



DR-100-24



NDR-240-24

Código	Referência	Alimentação	Saída	Potência	Corrente	PFC	DIM	IP	Class	CxLxA	Peso
1000120128	DR-30-24	85-264VAC + 120-370VDC	24V DC	30W	1.5A		NO	20	II	78*93*56 (mm)	0,27Kg
1000120131	DR-60-24	88-264VAC + 124-370VDC	24V DC	60W	2.5A		NO	20	II	78*93*56 (mm)	0,30Kg
1000120130	DR-100-24	88-264VAC + 124-370VDC	24V DC	100W	4.2A		NO	20	II	100*93*56 (mm)	0,35Kg
1000120129	NDR-240-24	90-264VAC + 127-370VDC	24V DC	240W	10A	PF>0.95	NO	20	I	63*125,2*113.5 (mm)	1,00Kg

## ESTANQUE



LPV-60-24



LPV-100-24



LPV-150-24



ELG-200-24



HLG-320H-24

Código	Referência	Alimentação	Saída	Potência	Corrente	PFC	DIM	IP	Class	CxLxA	Peso
1000120123	LPV-60-24	90-264VAC + 127-370VDC	24V DC	60W	2.5A		NO	67	II	162,5*42,5*32 (mm)	0,40Kg
1000120124	LPV-100-24	90-264VAC + 127-370VDC	24V DC	100.8W	4.2A		NO	67	II	190*52*37 (mm)	0,63Kg
1000120125	LPV-150-24	180 ~ 305VAC + 254 ~ 431VDC	24V DC	151.2W	6.3A		NO	67	II	191*63*37.5 (mm)	0,74Kg
1000120126	ELG-200-24	100 ~ 305VAC + 142 ~ 431VDC	24V DC	201.6W	8.4A	PF>0.95	NO	65	I	244*71*37.5 (mm)	1,22Kg
1000120127	HLG-320H-24	90 ~ 305VAC + 127 ~ 431VDC	24V DC	320.16W	13,34A	PF>0.95	NO	65	I	252*90*43,8 (mm)	1,88Kg

# ÍNDICE

## FONTES DE ALIMENTAÇÃO

Código	Referência	Descritivo	Página
1000120133	LRS-35-24	220-240V 24VDC 35W 1,5A IP20	33
1000120025	LRS-75-24	220-240V 24VDC 76,8W 3,2A IP20	33
1001002029	LRS-100-24	220-240V 24VDC 108W 4,5A IP20	33
1001001109	LRS-150-24	220-240V 24VDC 156W 6,5A IP20	33
1000120121	RSP-200-24	220-240V 24VDC 200W 40A IP20	33
1000120122	RSP-320-24	220-240V 24VDC 320W 40A IP20 (Ventilada)	33
1000120128	DR-30-24	220-240V 24VDC 30W 1,5A IP20 Calha DIN	33
1000120131	DR-60-24	220-240V 24 VDC 60W 2,5A IP20 Calha DIN	33
1000120130	DR-100-24	220-240V 24VDC 100W 4,2A IP20 Calha DIN	33
1000120129	NDR-240-24	220-240V 24VDC 240W 10A IP20 Calha DIN	33
1000120123	LPV-60-24	220-240V 24VDC 60W 2,5A IP67	33
1000120124	LPV-100-24	220-240V 24VDC 100,8W 4,2A IP67	33
1000120125	LPV-150-24	220-240V 24VDC 151,2W 6,3A IP67	33
1000120126	ELG-200-24	220-240V 24VDC 201,6W 8,4A IP65	33
1000120127	HLG-320H-24	220-240V 24VDC 320,16W 13,34A IP65	33
1000120134	Smart Control Mobile DLX1224-4CV-BLE	Sistema de controlo de iluminação via Bluetooth Alimentação 12-24Vdc Saída 4 Canais 4x2,5A.	28/29

## PERFÍS ALUMÍNIO E ACESSÓRIOS

Código	Referência	Descritivo	Página
1431001001P	AluPRO 90°	Perfil alumínio saliente 90° 2020x16x16mm com (difusor policarbonato opalino)	26/27
1430450001	Clip 90°	Clip de fixação para perfil alumínio Alupro 90	26/27
1432050001	TP90° - F	Topo final para perfil alumínio Alupro 90°	26/27
1432050002	TP90° - E	Topo c/entrada para perfil alumínio Alupro 90°	26/27
1431001002P	AluPRO/S	Perfil alumínio saliente 2020 x 17,1 x 7,9mm com (difusor policarbonato opalino)	26/27
1430450002	Clip - S	Clip de fixação para perfil alumínio Alupro / S	26/27
1432050005	TP/S- F	Topo final para perfil alumínio saliente Alupro / S	26/27
1432050004	TP/S - E	Topo c/entrada para perfil alumínio saliente Alupro / S	26/27
1431001003P	AluPRO/E	Perfil alumínio encastrar com aba 2020 x 23,2mm com (difusor policarbonato opalino)	26/27
1432050003	TP/E - F	Topo final para perfil alumínio encastrar com aba Alupro / E	26/27
1432050006	TP/E - E	Topo c/entrada para perfil alumínio encastrarcom aba Alupro / E	26/27

# ÍNDICE

FITAS | CONTROLADORES | CONECTORES

Código	Modelo	Potência	Lumens/ MT	IP	CRI	Temp. cor	Página	Controlador	Código.	Pág	Conector / Código	Pág	
1431000010	Flexistrip	23W	1625Lm	IP20	<b>Ra&gt;94</b>	3000K	04/05	Dimmer	1430560001	30	União Conector Extensão	1430490007 1431240007 1430810007	24
1431000011	Flexistrip	23W	1735Lm	IP20	<b>Ra&gt;94</b>	4000K	04/05	Dimmer	1430560001	30	União Conector Extensão	1430490007 1431240007 1430810007	24
1431000006	Flexistrip	14,4W	990Lm	IP20	<b>Ra&gt;94</b>	3000K	06/07	Dimmer	1430560001	30	União Conector Extensão	1430490002 1431240002 1430810004	24
1431000007	Flexistrip	14,4W	1050Lm	IP20	<b>Ra&gt;94</b>	4000K	06/07	Dimmer	1430560001	30	União Conector Extensão	1430490002 1431240002 1430810004	24
1431000008	Flexistrip	9,6W	740Lm	IP20	Ra>80	3000K	08/09	Dimmer	1430560001	30	União Conector Extensão	1430490006 1431240006 1430810006	24
1431000009	Flexistrip	9,6W	768Lm	IP20	Ra>80	4000K	08/09	Dimmer	1430560001	30	União Conector Extensão	1430490006 1431240006 1430810006	24
1431000004	Flexistrip	4,8W	360Lm	IP20	Ra>80	3000K	10/11	Dimmer	1430560001	30	União Conector Extensão	1430490001 1431240001 1430810003	24
1431000005	Flexistrip	4,8W	390Lm	IP20	Ra>80	4000K	10/11	Dimmer	1430560001	30	União Conector Extensão	1430490001 1431240001 1430810003	24
1431000012	Conforstrip WW+W	14,4W	1200Lm	IP20	Ra>90	2700K > 6500K	12/13	WW+W	1430560004	30	União Conector Extensão	1430490005 1431240005 1430810005	24
1431000013	Flexiproof	14,4W	990Lm	<b>IP65</b>	<b>Ra&gt;94</b>	3000K	14/15	Dimmer	1430560001	30	União Conector Extensão	1430490002 1431240002 1430810004	24
1431000014	Flexiproof	14,4W	1050Lm	<b>IP65</b>	<b>Ra&gt;94</b>	4000K	14/15	Dimmer	1430560001	30	União Conector Extensão	1430490002 1431240002 1430810004	24
1431000015	Flexiproof	9,6W	740Lm	<b>IP65</b>	Ra>80	3000K	16/17	Dimmer	1430560001	30	União Conector Extensão	1430490006 1431240006 1430810006	24
1431000016	Flexiproof	9,6W	768Lm	<b>IP65</b>	Ra>80	4000K	16/17	Dimmer	1430560001	30	União Conector Extensão	1430490006 1431240006 1430810006	24
1431000001	Colorstrip	14,4W	420Lm	IP20		RGB	18/19	RGB	1430560002	30	União Conector Extensão	1430490003 1431240003 1430810001	25
1431000002	Colorstrip	14,4W	420Lm	<b>IP65</b>		RGB	20/21	RGB	1430560002	30	União Conector Extensão	1430490003 1431240003 1430810001	25
1431000003	Colorstrip W	14,4W	610Lm	IP20		RGB + 6000K	22/23	RGB+W	1430560003	31	União Conector Extensão	1430490004 1431240004 1430810002	25

As indicações, descrições, ilustrações, fotografias constantes neste catálogo, são válidas para os artigos em stock, e poderão ser alvo de alteração sem aviso prévio, pelo que aconselhamos que consulte o fornecedor habitual.



SOLUÇÕES  
PARA  
PROJECTOS  
EXIGENTES

A photograph of a modern hallway with a textured wall and recessed lighting. The hallway is carpeted and has a blue baseboard. The lighting is warm and creates a soft glow. The text is overlaid on the right side of the image.

# TABELA DE PREÇOS

FLEXISTRIP  
FLEXIPROOF  
CONFORSTRIP  
COLORSTRIP

[www.lumitek.pt](http://www.lumitek.pt)



 **Lumitek**<sup>®</sup>  
Iluminação

